

Residential & Light Commercial HVAC Zoning System for 3 to 8-Zones

SmartZone-4X/8X

- **ECONOMY INPUT**
- **USE ANY THERMOSTAT**
- **ELECTRONIC LIMIT CONTROL™(ELC)**
- **SUPPLY AIR SENSOR INCLUDED**
- **GAS/ELECTRIC & HEAT PUMP & DUAL FUEL**
- **2-Stage Cooling, 3-Stage Heating**
- **HIGH-END FEATURES AT LOW COST**
- **5-YEAR LIMITED WARRANTY**

SmartZone-4X 4-Zone Controller

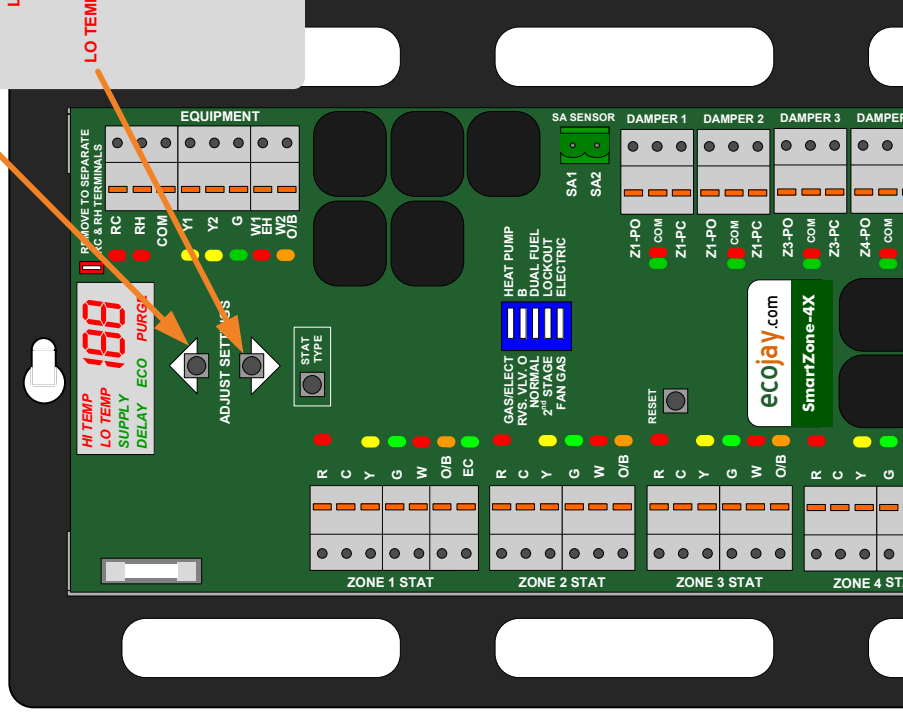

PUSH BUTTONS & DISPLAY

- SUPPLY** = Supply Air Temperature displayed.
- PURGE** = System is in PURGE mode for equipment changeover (Fan [G] and dampers continue to operate)
- HI TEMP (ON)** = HIGH TEMP LIMIT sensed, SmartZone Controller shuts off HEAT output for a minimum of 3 minutes (Fan [G] and damper outputs continues to operate)
- HI TEMP (FLASHING)** = Setting HIGH TEMP LIMIT – Press UP or DOWN Arrow Buttons to adjust the HIGH TEMP LIMIT (factory default: heat pump – 120° F; electric heat – 135° F; gas heat – 135° F)
- LO TEMP (ON)** = LOW TEMP LIMIT sensed, SmartZone Controller shuts off the COOL output for a minimum of 3 minutes (Fan [G] and damper outputs continue to operate)
- LO TEMP (FLASHING)** = Setting LOW TEMP LIMIT – Press the UP or DOWN Arrow Buttons to adjust the LOW TEMP LIMIT (factory default 48° F)
- DELAY** = SmartZone Controller has satisfied all calls and will DELAY 3 min before initiating any additional calls.
- ECO** = EC input on Zone 1 is energized and system is in ECONOMY MODE. Only Zone 1 can initiate equipment calls, other zones will only open and close dampers as needed.

SmartZone is a residential or light commercial HVAC zoning control system capable of controlling up to eight (8) zones on a single forced-air GAS/ELECTRIC, HEAT PUMP OR DUAL FUEL system. Each **SmartZone-4X/8X** system utilizes standard thermostats (Gas/Electric or Heat Pump) and dampers to manage comfort of the individual zones. The SmartZone controller can operate 2 stages of compressor and 2 stages of heating plus auxiliary heat for heat pump equipment.

AVAILABLE ONLINE

OTHER DOCUMENTS:
SmartZone-4X/8X SpecsSheet
SmartZone System Manual

WATCH FREE TRAINING VIDEOS

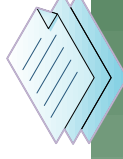

FOSSIL FUEL (DUAL FUEL) AUX. HEAT

Note 1: A DUAL FUEL KIT IS NOT REQUIRED and HEAT PUMP THERMOSTATS ARE NOT REQUIRED. However, use a Heat Pump stat for the ZONE 1 Thermostat only to control EMERGENCY HEAT.

Note 2: Always install the heat pump evaporator downstream of the furnace. This prevents condensation in the heat exchanger during the cooling mode.

EMERGENCY HEAT

- Emergency Heat can only be initiated through a heat pump thermostat connected to the ZONE 1 thermostat terminal.
- If this thermostat (ZONE 1) is set to Emer. Heat, the SmartZone™ system is LOCKED into emergency heat. The compressor will not energize and only heating calls will be recognized from any zone other than ZONE 1.
- Only W1/VEH and G will remain energized for the remainder of the heating cycle.
- To "UNLOCK" and take the system out of Emergency Heat. Remove the Emer. Heat call at the ZONE 1 thermostat and make a call for compressor heat or cooling from this thermostat.

RC/RH JUMPER

The RC/RH Jumper is Factory Installed on the SmartZone™ Controller Board. If the system being used requires separate Heat and Cool Transformers, REMOVE this jumper [JP2] at the top right of the board.

Note: In the case of a Heat-Pump System, this jumper ALWAYS needs to be installed.

PURGE

Purge Mode lasts three (3) minutes during which the Fan [G] continues to operate during Opposing-Call Changeover. (Switching from Heat to Cool or Cool to Heat) During the Purge, heating or cooling equipment will not be energized. Purge mode is designed to allow HVAC system pressures and temperatures can equalize. During the Purge Mode, zone(s) calling for the opposite mode will have damper(s) closed. All other dampers (non-calling zone(s) and zone(s) calling for mode last energized) will remain open during Purge Mode

TIME DELAY

After all calls have been satisfied and the equipment is de-energized, all dampers open and a 3-minute Time DELAY will be completed before new thermostat calls will be processed. This is designed to protect the equipment from re-starting for 3-minutes after it has stopped running. The SmartZone™ Controller will not energize the fan. However, the fan may continue to run if the equipment being used has a built in "off-time-delay."

SmartZone Equipment Staging

- 1st stage energizes anytime there is a thermostat call from any zone on the system.
- 2nd stage occurs after time and temperature criteria have been met as shown in the illustrations.
- 3-minute minimum run-time for second stage compressor.

EXCEPTION: If DIP switch #4 is in the 'LOCK OUT' position:

2nd Stage WILL NOT energize unless MORE than one (1) zone is calling for the same mode.

COOLING (ALL)

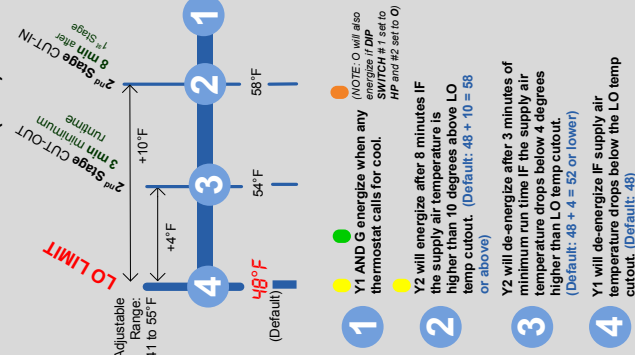

HEATING (Gas/Electric & Fuel Oil)

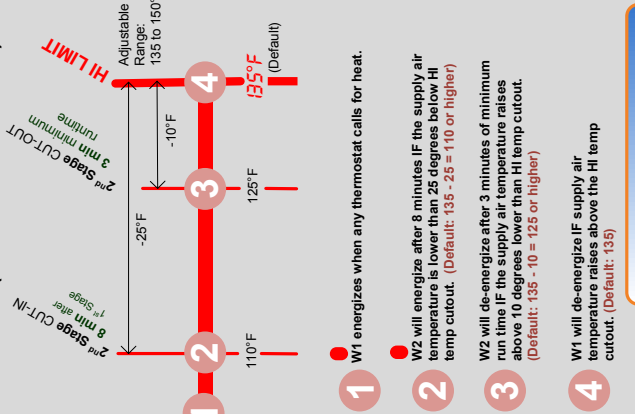

HEATING (Heat Pump)

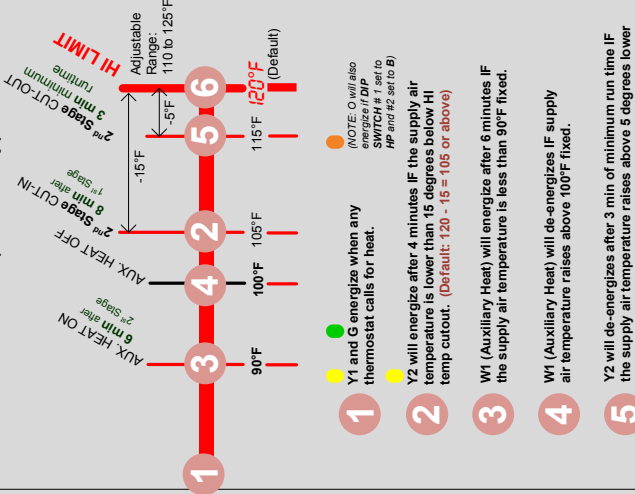

NOTE: Changing the HI LIMIT and LO LIMIT temperatures with the pushbuttons WILL ALSO change the 2nd-Stage CUT-IN and CUT-OUT temperatures. See above illustration for details.

Thermostat Backplate
(Heat Pump w/ EH Control wiring shown)

ECONOMY MODE SWITCH

(OPTIONAL) CONNECT 24V and EC INPUT to set the SmartZone System into ECONOMY MODE. ECONOMY MODE enables only ZONE 1 on Main Controller (MC) to make equipment calls. All other zone calls will open and close dampers as needed to take advantage of the active mode thermostat on the main controller.

APPLICATION: A simple timer could be used to set the entire system into economy mode after-hours OR a wall switch connected to this terminal would allow the user to simply 'switch' the system into ECONOMY MODE



Thermostats MUST have a COMMON or be BATTERY Operated

1 THERMOSTAT WIRING

USE 18 GAUGE Solid Conductor Wire
For a HEAT PUMP System with Emer. Heat: ZONE 1 TStat only will have the ability to control Emergency Heat.

THERMOSTAT	COLOR (TYPICAL)	SmartZone
24VAC (HOT)	RED	R
24VAC (COMMON)	-- no standard	C
COMPRESSOR	YELLOW	Y
FAN	GREEN	G
HEAT or EMERGENCY HEAT	WHITE	W
REVERSING VALVE	ORANGE	O/B

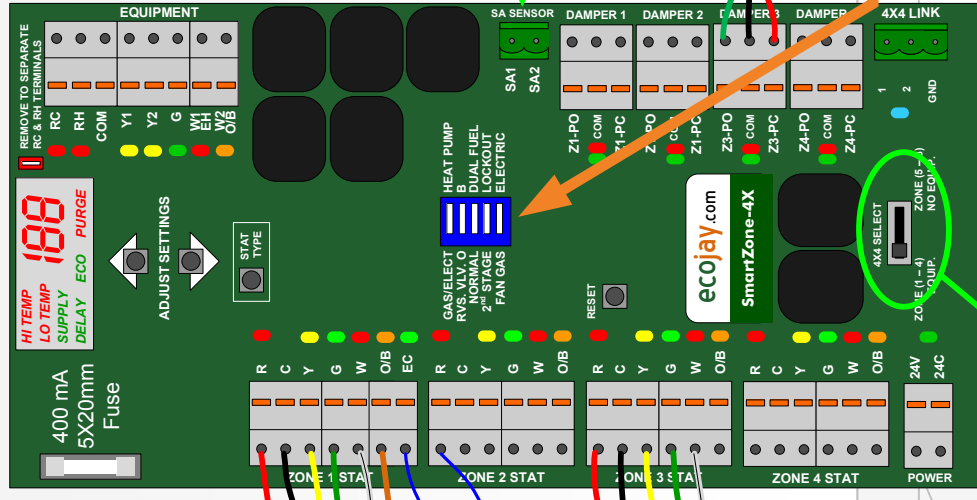

FOR NORMAL OPERATION
4X4 SELECT SWITCH MUST BE SET TO ZONE (1 - 4)

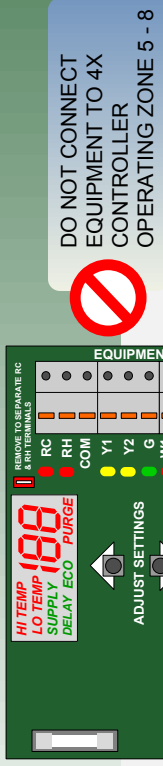

TRANSFORM TWO SmartZone-4X BOARDS into an 8 zone system with only TWO Simple Steps.

Complete 4X4 Link setup before powering 4X boards.

1

CONNECT 4X4 LINK CABLE or use CAT5(e)/CAT6 cable (USING EZ PLUG CONNECTORS)

2

SWITCH "4X4 SELECT" to "ZONE (5 - 8)" on second 4X controller - (the first 4X controller should be switched to "ZONE (1 - 4)")

BLUE 4X4 LINK LED Flashing indicates communication established with **ZONE(1 - 4) Board** if LED is OFF or **SOLID BLUE**, check 4X4 Link cable wiring or transformer(s) polarity.

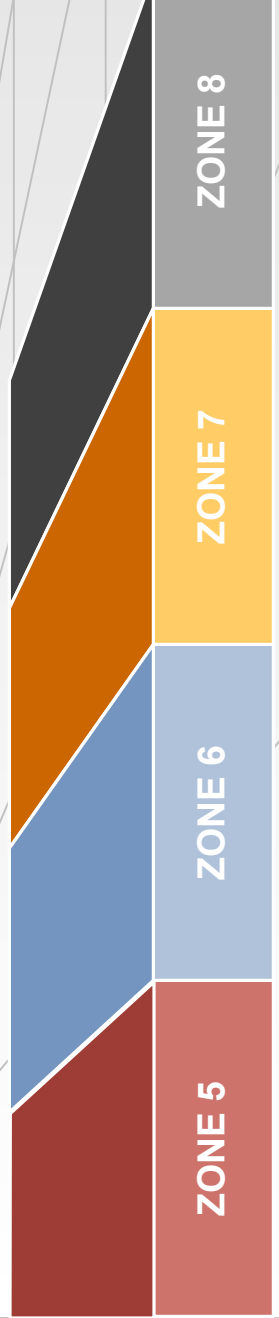

8-ZONE System
using exclusive
4X4 LINK

EQUIPMENT WIRING

Connect MAIN 4X Board EQUIPMENT Terminal Normally (as shown on page 4)
Do not connect equipment to 4X Controller operating Zones 5 - 8.

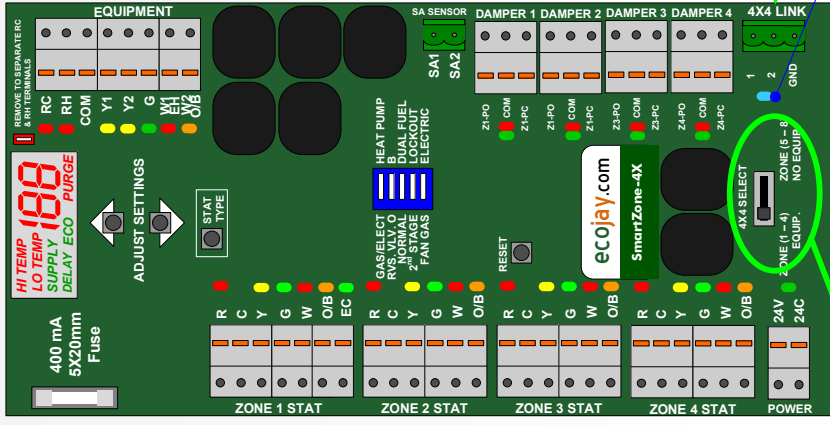

BLUE 4X4 LINK LED should ALWAYS be Flashing on the ZONE(1 - 4) Board
If LED is OFF or SOLID BLUE, check 4X4 Link cable wiring or transformer(s) polarity.

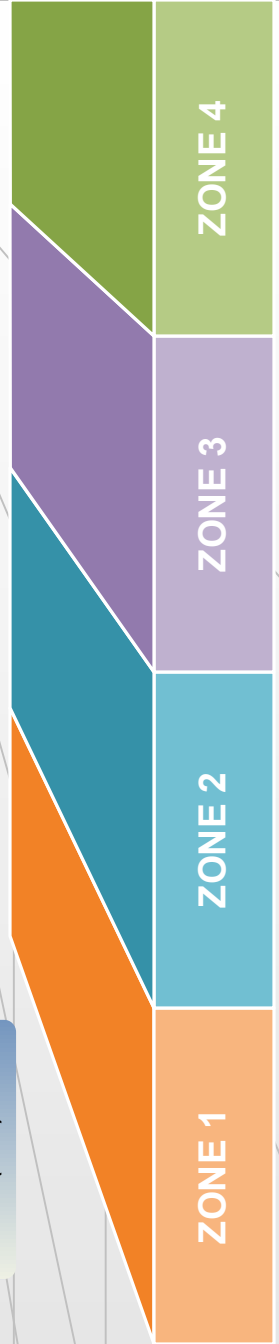

2 SUPPLY AIR SENSOR (SAS)

NOTE: WITHOUT this sensor, the SmartZone will ONLY respond to Zone 1 TStat and ONLY operate in 1st Stage.

Gas/Electric – The SA Sensor should be placed in the airstream, 2 to 4 feet beyond the evaporator.
Heat Pump with Dual Fuel– Same as Gas/Electric (described above)

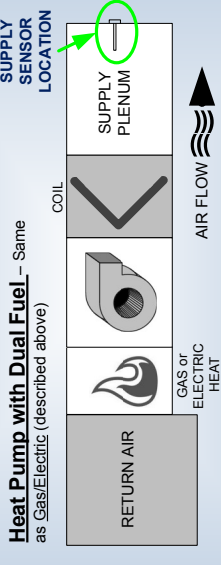

Heat Pump (Standard) – The SA Sensor should be placed in the air handler AFTER the COIL but BEFORE the BLOWER.

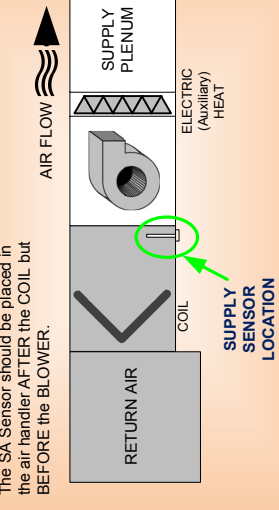

3

ZONE DAMPER WIRING

USE 18 Gauge Solid Conductor Wire
Multiple Dampers can be wired to each zone as necessary based on duct configuration. Up to 10 (3-Wire) dampers can be wired to any one zone damper terminal. Any 24VAC Damper can be used.

SAS
4" Stainless Probe w/ 10 ft wire lead

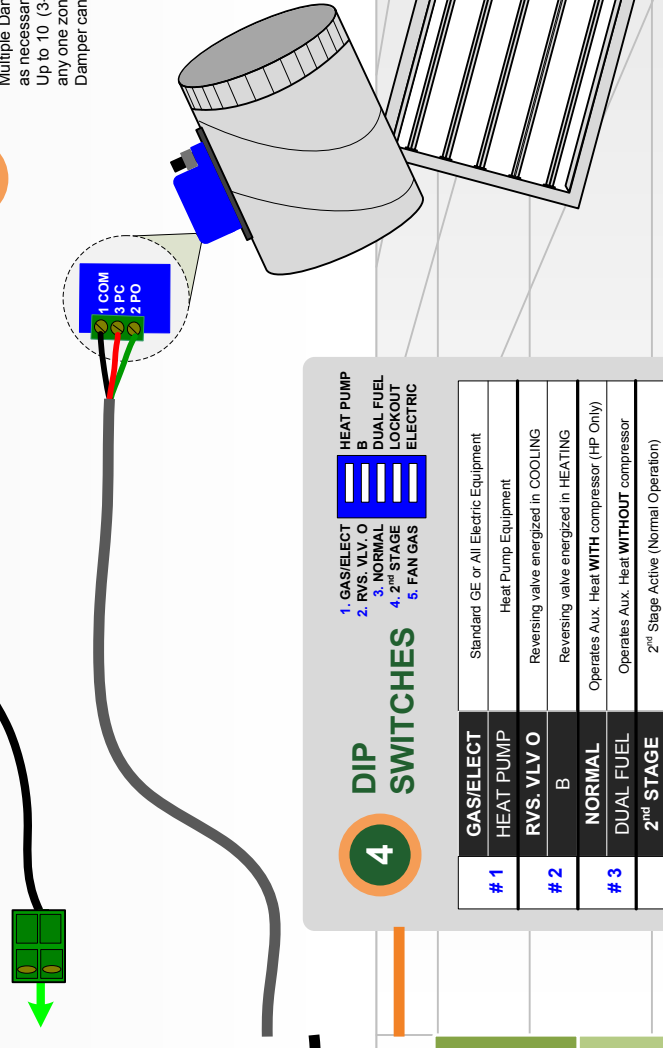

4

DIP SWITCHES

- 1. GAS/ELECTRIC
- 2. RVS. VLV. O B
- 3. NORMAL
- 4. 2nd STAGE LOCKOUT
- 5. FAN GAS

#	DIP SWITCH	HEAT PUMP	DUAL FUEL LOCKOUT	ELECTRIC
# 1	GAS/ELECTRIC	Standard GE or All Electric Equipment		
# 2	HEAT PUMP RVS. VLV. O B	Heat Pump Equipment	Reversing valve energized in COOLING	
# 3	NORMAL	Operates Aux. Heat WITH compressor (HP Only)	Reversing valve energized in HEATING	
# 4	DUAL FUEL 2 nd STAGE LOCKOUT	Operates Aux. Heat WITHOUT compressor	2 nd Stage Active (Normal Operation)	
# 5	FAN GAS	2 nd Stage will not energize if only ONE zone open	Energizes fan after 45 second delay in heating	
	ELECTRIC	Energizes fan immediately with heating		

6 THERMOSTAT TYPE SETUP

NOTE: On Heat Pump equipment, either Gas/Electric or Heat Pump Thermostats can be used. The SmartZone controller **MUST** be set for the thermostat type being used or the equipment will not operate properly.

- Press the STAT TYPE Button Once to set the Zone 1 Thermostat Type. The display will flash 1 – GE or HP.
- Press the UP or DOWN Arrow Button to toggle between GE or HP (Gas/Electric or Heat Pump)
- Press the STAT TYPE Button AGAIN (twice) to set the Zone 2 Thermostat Type. The display will flash 2 – GE or HP
- Press the UP or DOWN Arrow Button to toggle between GE or HP (Gas/Electric or Heat Pump)
- Repeat STEPS 3 and 4 to complete thermostat type setup for Zones 3 and 4.

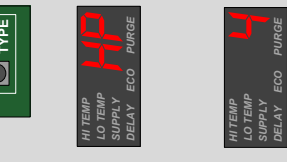

Connect Equipment according to manufacturers instructions.

7 EQUIPMENT WIRING

USE 18 GAUGE Solid Conductor Wire
NOTE: Disconnect power to equipment transformer while wiring zoning board.

EQUIPMENT	COLOR (TYPICAL)	SmartZone
24VAC - COOLING	RED	RC
24VAC - HEATING	RED	RH
24VAC (COMMON)	-- no standard	C
COMPRESSOR (STAGE 1)	YELLOW	Y1
COMPRESSOR (STAGE 2)	-- no standard	Y2 (OPTIONAL)
FAN (BLOWER)	GREEN	G
HEAT (STAGE 1) or EMER. HEAT	WHITE	W1-EH
HEAT (STAGE 2) or RVS. VALVE	ORANGE	W2-OIB (OPTIONAL)

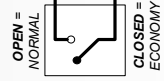
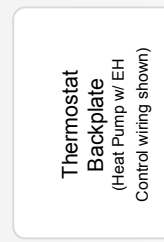
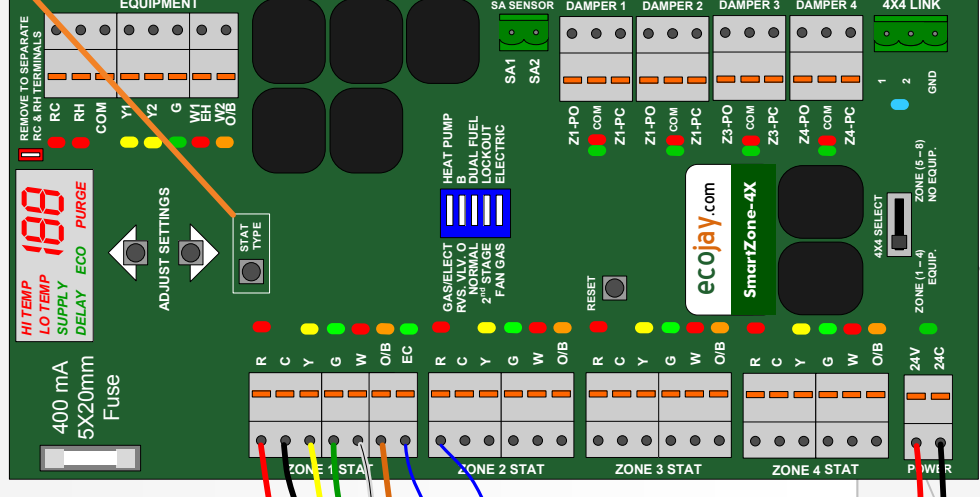

5 POWER (24 VAC)
 SmartZone System **MUST BE POWERED WITH AN INDEPENDENT, FUSED TRANSFORMER.** The size of this transformer(s) will be determined with the TABLE below.

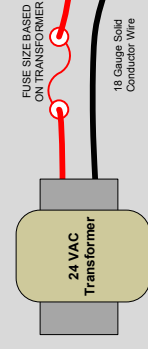

FIELD SUPPLIED TRANSFORMER MUST BE SIZED BASED ON THE 4X CONTROLLER, TOTAL DAMPERS AND THERMOSTATS.

ECOJAY Device	POWER
SmartZone-4X	14 VA
Power Open/Close Damper	3 VA
Spring Return Damper	10 VA
Typical Thermostat	3 VA

EXAMPLE:
 SMARTZONE-4X, 4 POWER OPEN/CLOSE DAMPERS, 4 THERMOSTATS
 14 + (3 X 4) + (3 X 4) = 38 VA